

# MEDE TECHNIK

## INHALTSVERZEICHNIS

## CONTENTS

### **KF - KNOCHENHALTEZANGEN**

Knochenhaltezangen

2

### **KF - BONE HOLDING FORCEPS**

*Bone Holding Forceps*

2



Ausgabe: 12/2010

CERTIFICATES DIN EN ISO 13485

**MEDE Technik**

Rudolf-Diesel-Str. 13  
D-78576 Emmingen

Tel: +49 (0)7465 893  
Fax: +49 (0)7465 2262

info@mede.de  
www.mede.de



**KNOCHENHALTEZANGEN**  
**BONE HOLDING FORCEPS**

PINZAS PARA HUESOS  
 DAVIERS PORTE-OS  
 TENAGLIE PER OSSA

KF



Sequesterzange  
 20cm

KF.130.20



KF.131.20



Van Buren  
 23cm  
 KF.135.23

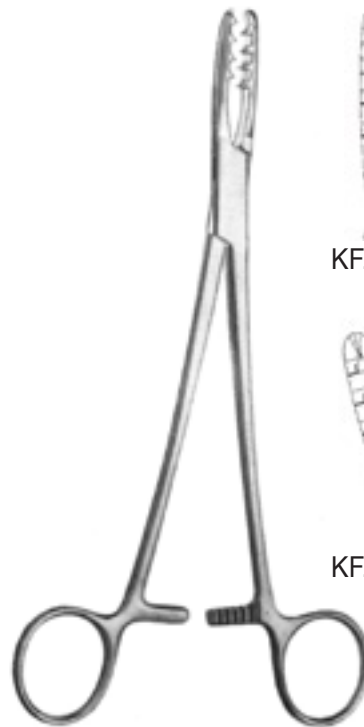

Bircher-Ganske  
 20cm

KF.140.20



KF.141.20



Bircher-Ganske  
 20cm  
 KF.142.20



KF.149.19



KF.149.89



Dingmann  
 18,5cm



Martin

KF.154.12 = 12cm  
 KF.152.19 = 19cm



Knochenfaßzange  
14cm  
KF.145.14



Langenbeck Knochenfaßzange  
21cm  
KF.184.21



Repositionszange  
13,5cm  
KF.168.90

**KNOCHENHALTEZANGEN**  
**BONE HOLDING FORCEPS**

PINZAS PARA HUESOS  
DAVIERS PORTE-OS  
TENAGLIE PER OSSA

KF



Setter  
16cm  
KF.162.16



Setter  
24cm  
KF.162.24



KF.168.09 = 9cm  
KF.168.14 = 14cm



Reil  
17cm  
KF.169.17

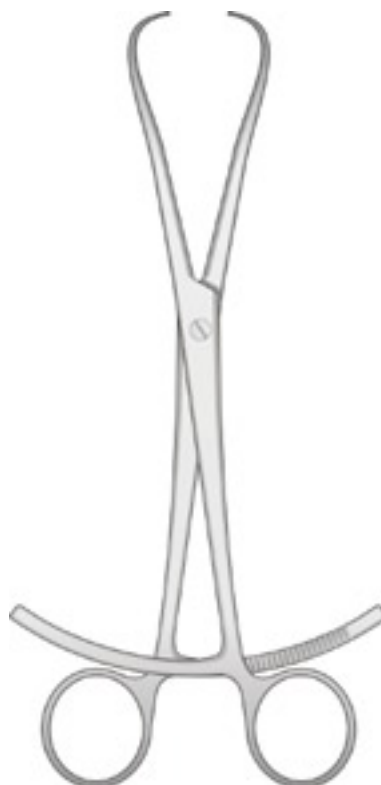

Repositionszange  
20cm  
KF.170.20



Patella  
18,5cm  
KF.172.18



Langenbeck  
21cm  
KF.180.21



Fergusson  
21cm  
KF.182.21



20cm  
KF.186.20

**KNOCHENHALTEZANGEN**  
**BONE HOLDING FORCEPS**

PINZAS PARA HUESOS  
DAVIERS PORTE-OS  
TENAGLIE PER OSSA

KF



Kern  
KF.200.15 = 15cm  
KF.200.17 = 17cm  
KF.200.21 = 21cm

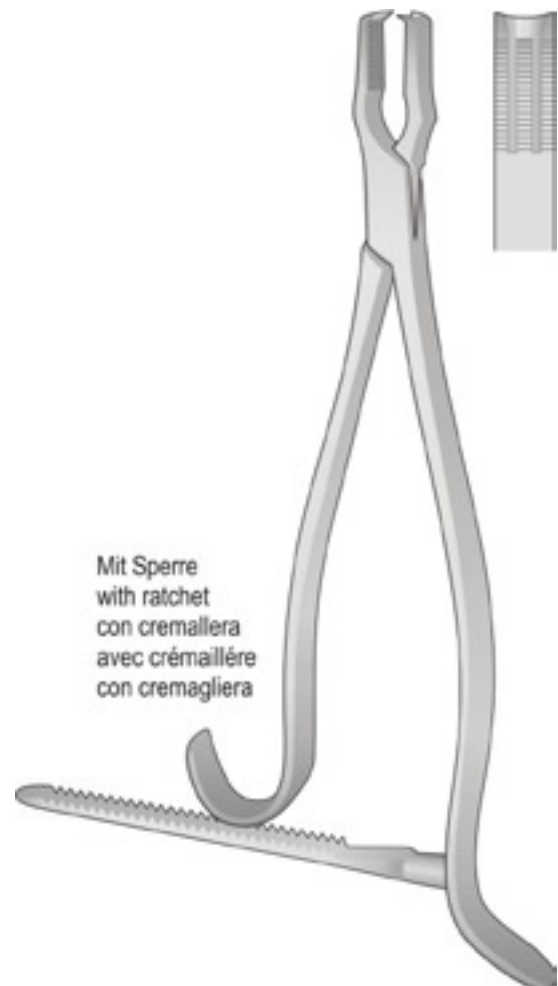

Mit Sperre  
with ratchet  
con cremallera  
avec crémailière  
con cremagliera

Kern  
KF.202.15 = 15cm  
KF.202.17 = 17cm  
KF.202.21 = 21cm



Lane  
KF.204.33 = 33cm  
KF.204.45 = 45cm



Lane  
KF.205.33 = 33cm  
KF.205.45 = 45cm



Semb  
19cm  
KF.210.19



Semb  
19cm  
KF.211.19

**KNOCHENHALTEZANGEN**  
**BONE HOLDING FORCEPS**

PINZAS PARA HUESOS  
DAVIERS PORTE-OS  
TENAGLIE PER OSSA

KF

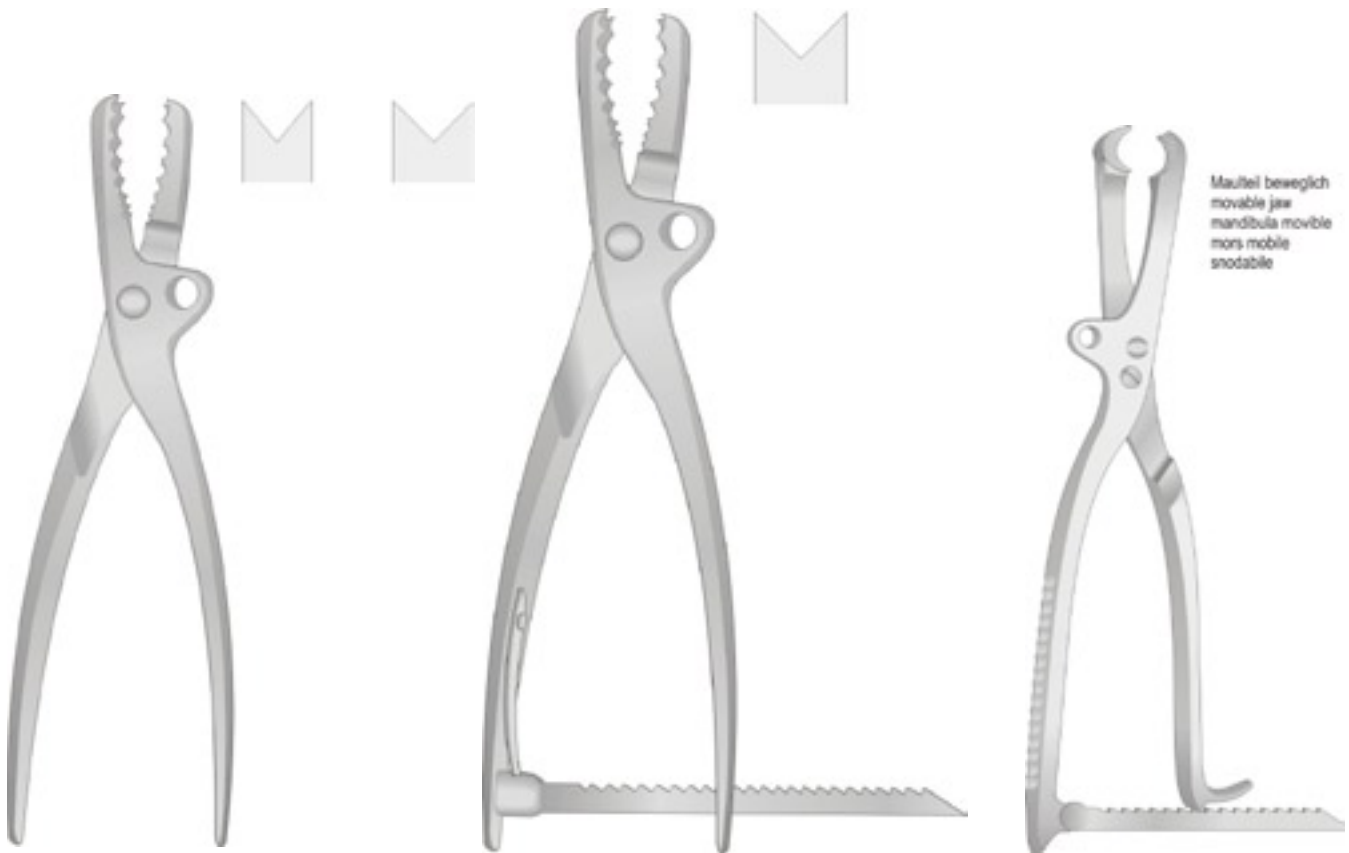

Farabeuf  
KF.220.23 = 23cm  
KF.220.26 = 26cm

Farabeuf-Lambotte  
26cm  
KF.224.26

Lambotte  
KF.228.22 = 22cm  
KF.228.27 = 27cm



Lambotte  
KF.230.22 = 22cm  
KF.230.26 = 26,5cm



Lambotte  
33cm  
KF.232.33



Lambotte  
27.5cm  
KF.236.28



Lambotte  
21.5cm  
KF.234.22

**KNOCHENHALTEZANGEN**  
**BONE HOLDING FORCEPS**

PINZAS PARA HUESOS  
 DAVIERS PORTE-OS  
 TENAGLIE PER OSSA

KF



19,0cm  
 KF. 250.19

23,0cm  
 KF. 250.23

25,0cm  
 KF. 250.25

28,0cm  
 KF. 250.28

Ulrich



19,0cm  
 KF. 251.19

23,0cm  
 KF. 251.23

25,0cm  
 KF. 251.25

28,0cm  
 KF. 251.28



Ulrich

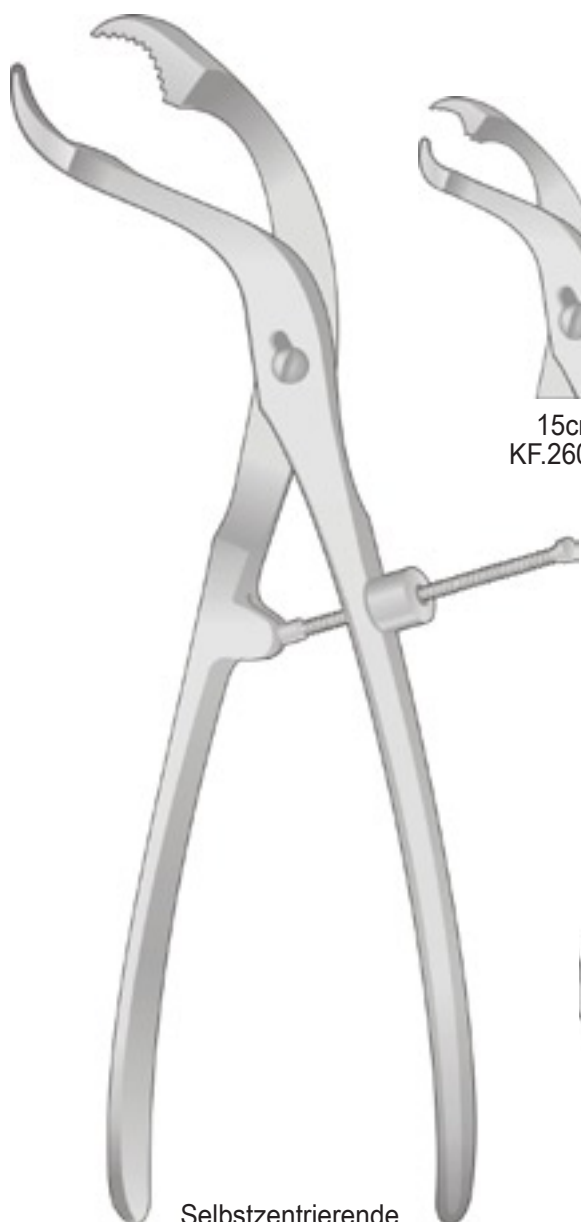

15cm  
KF.260.15



19cm  
KF.260.19



24cm  
KF.260.24



Selbstzentrierende  
Knochenhalte-  
zange  
mit Gewin-  
desperre

Self-centering  
forceps  
with thread  
fixation

fórceps  
autocentrante  
con  
tope de fijación

á centrage  
automatique  
avec arrê-  
t de filetage

autocentrante  
con blocco  
di filettatura

26cm  
KF.260.26



28cm  
KF.260.28



**KNOCHENHALTEZANGEN**  
**BONE HOLDING FORCEPS**

PINZAS PARA HUESOS  
DAVIERS PORTE-OS  
TENAGLIE PER OSSA

KF

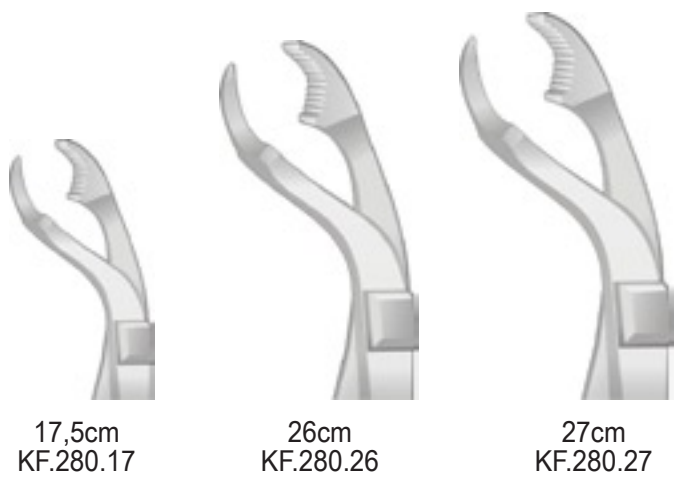

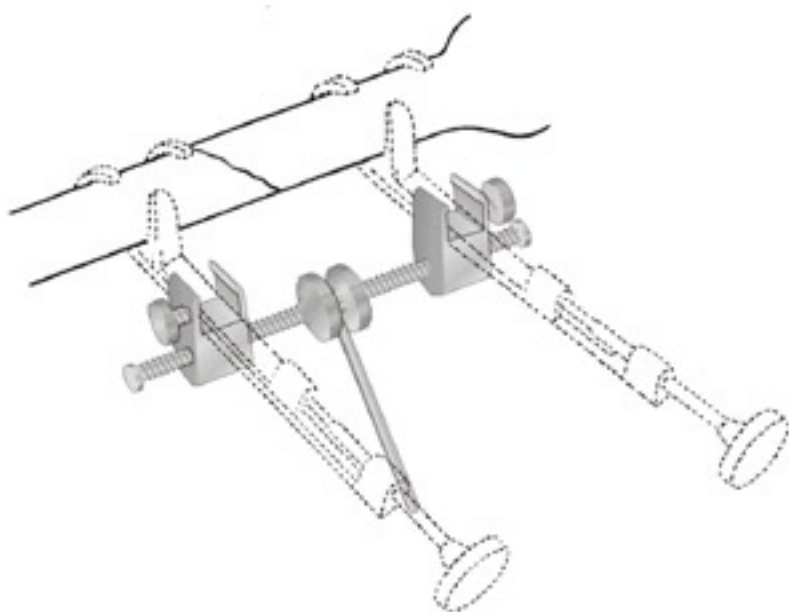

Gerster Distraktionsklammer  
KF.420.15  
passend für Lowman Knochenhalteklammern



Lowman  
KF.400.12 = 12cm  
KF.400.18 = 18cm  
KF.400.20 = 20cm



Knochenfaßzange  
26cm

